

## ENERGIZER NO. X22

**9V**

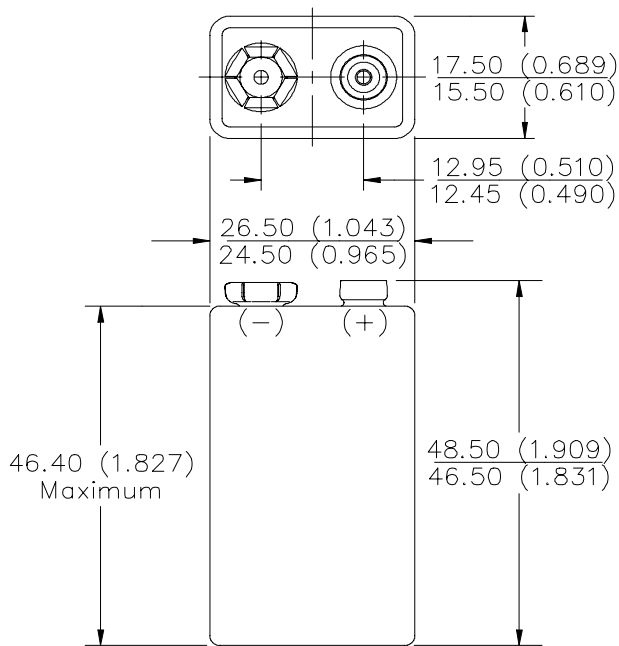

Industry Standard Dimensions in mm (inches)



**Chemical System:** Alkaline  
 Zinc-Manganese Dioxide (Zn/MnO<sub>2</sub>)  
 (No Added Mercury or Cadmium)

**Designation:** ANSI-1604A, IEC-6LR61

**Battery Voltage:** 9.0 Volts

**Operating Temp:** -18°C to 55°C (0°F to 130°F)

**Average Capacity:** 655 mAh (to 0.8 volts/cell)  
 (Rated capacity at 25 mA continuous drain)

**Average Weight:** 45.6 grams (1.6 oz.)

**Volume:** 21.1 cubic centimeters (1.3 cubic inch)

**Cell:** Six No. 3-0316 in series

**Jacket:** Metal

**Shelf Life:** 5 years (80% of rated capacity)

**TEMPERATURE EFFECTS**  
 Typical Service to 4.8 Volts

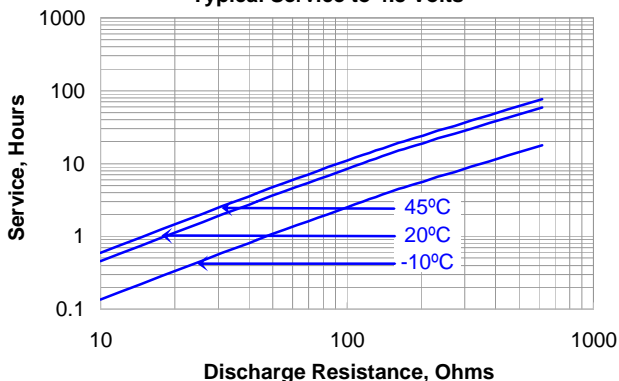

**CONSTANT RESISTANCE PERFORMANCE**  
 Typical Service

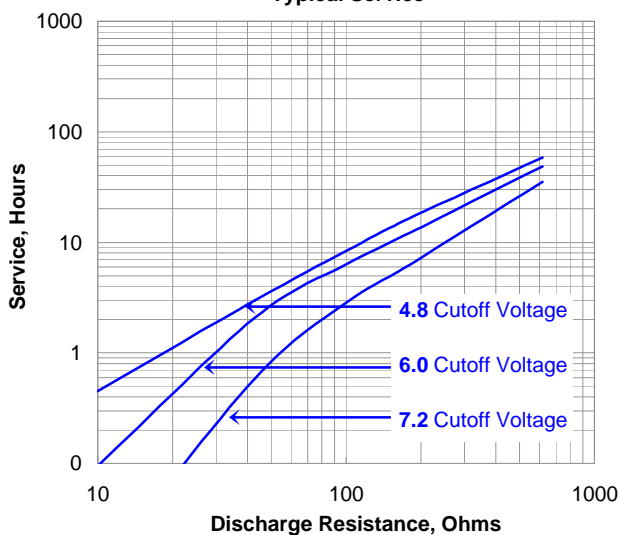

**CONSTANT CURRENT DISCHARGE**  
 Typical Service

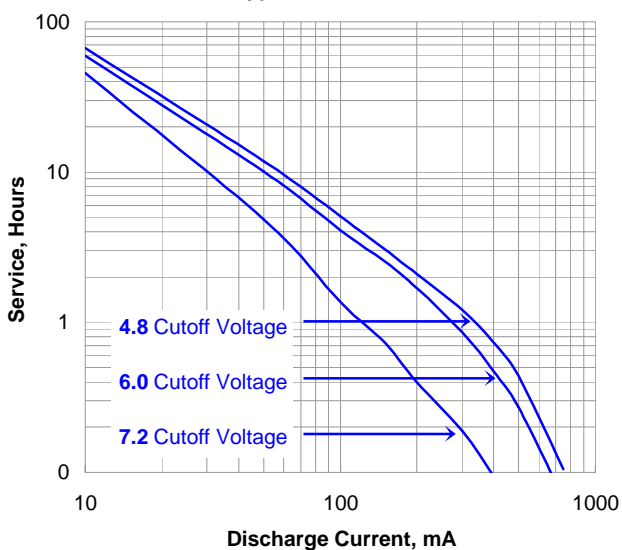

### Important Notice

This data sheet contains information specific to batteries manufactured at the time of its publication.

**Contents herein do not constitute a warranty.**

Copyright © Eveready Battery Co. - All rights reserved

**ENERGIZER NO. X22**

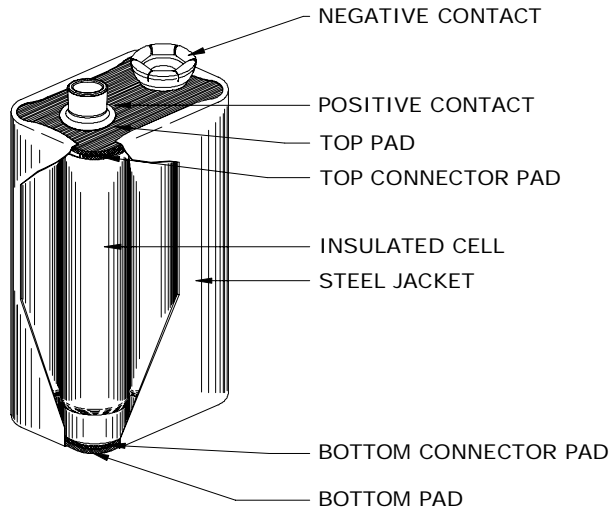

**Industry Standard Tests @ 20° C**

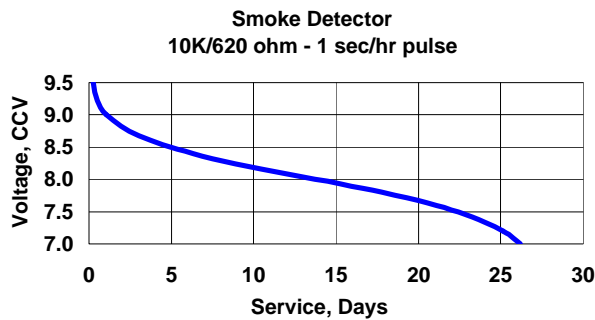
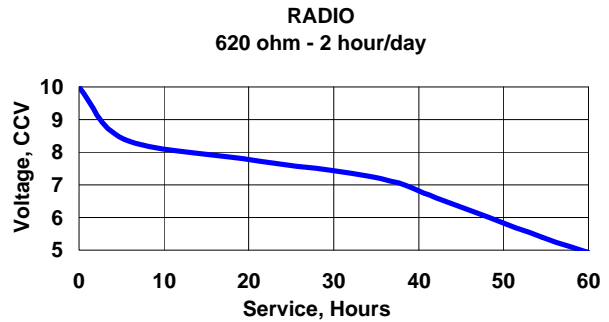
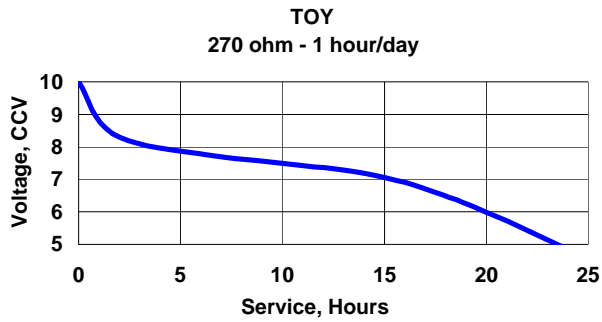

**Important Notice**

This data sheet contains information specific to batteries manufactured at the time of its publication.

**Contents herein do not constitute a warranty.**

Copyright © Eveready Battery Co. - All rights reserved