

## ENERGIZER NO. X91

## AA

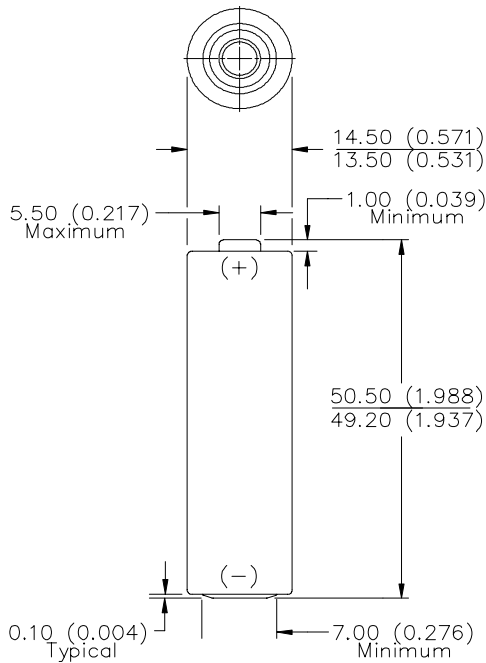

Industry Standard Dimensions in mm (inches)



**Chemical System:** Alkaline  
 Zinc-Manganese Dioxide (Zn/MnO<sub>2</sub>)  
 (No Added Mercury or Cadmium)

**Designation:** ANSI-15A, IEC-LR6

**Battery Voltage:** 1.5 Volts

**Internal Resistance:** 146 Milliohms (Fresh)

**Operating Temp:** -18°C to 55°C (0°F to 130°F)

**Average Capacity:** 2,850 mAh (to 0.8 volts)  
 (Rated capacity at 25 mA continuous drain)

**Average Weight:** 23.0 grams (0.8 oz.)

**Volume:** 8.1 cubic centimeters (0.5 cubic inch)

**Cell:** One No. 3-315 (size 'AA')

**Jacket:** Plastic Label

**Shelf Life:** 7 years (80% of rated capacity)

TEMPERATURE EFFECTS  
 Typical Service to 0.8 Volts

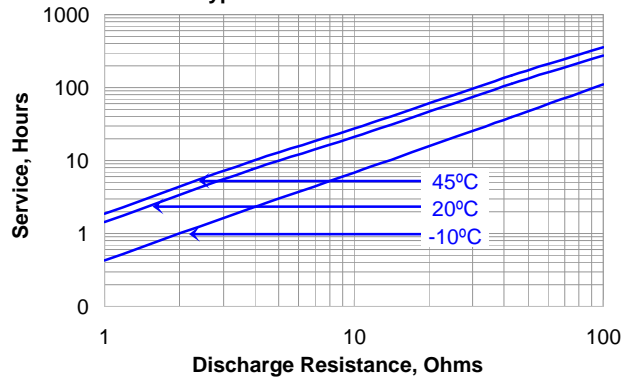

CONSTANT RESISTANCE PERFORMANCE  
 Typical Service

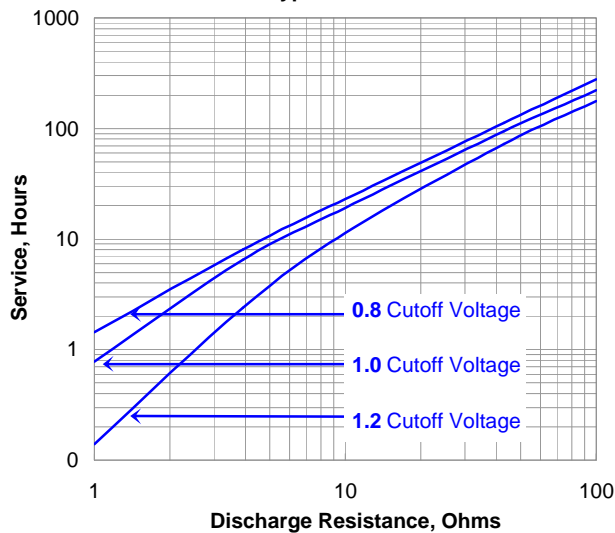

CONSTANT CURRENT DISCHARGE  
 Typical Service

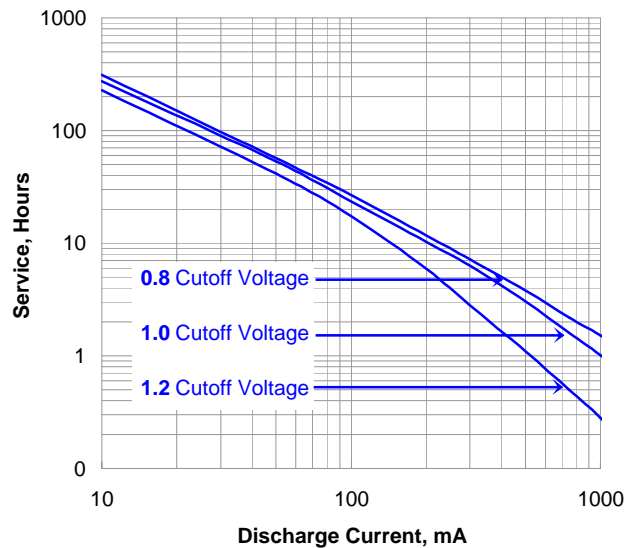

### Important Notice

This data sheet contains information specific to batteries manufactured at the time of its publication.

**Contents herein do not constitute a warranty.**

Copyright © Eveready Battery Co. - All rights reserved

## ENERGIZER NO. X91

CONSTANT POWER DISCHARGE  
Typical Service

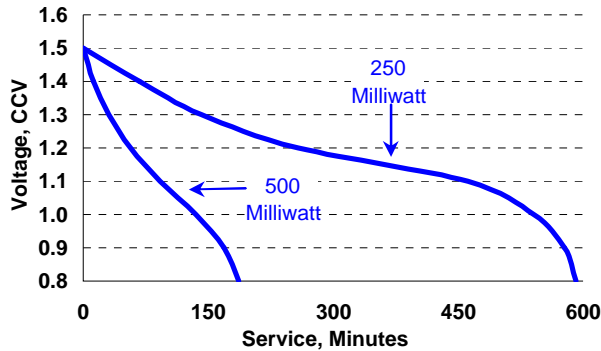

CONSTANT POWER DISCHARGE  
Typical Service

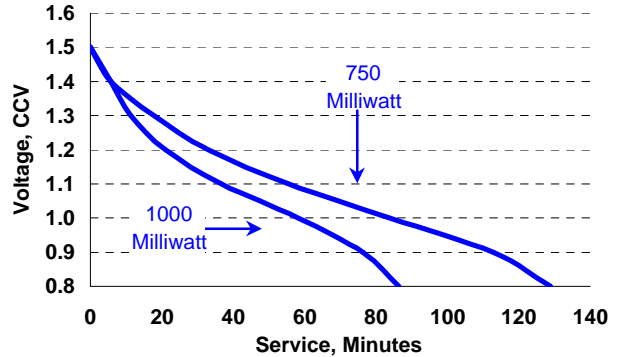

### Industry Standard Tests @ 20° C

RADIO  
43 ohm - 4 hours/day

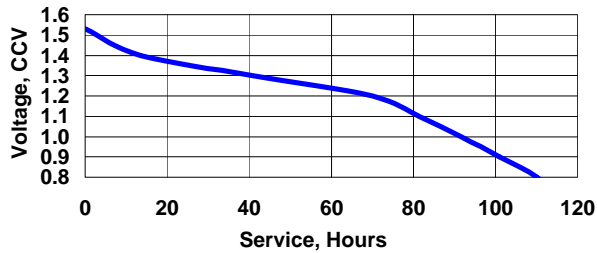

LIGHTING 3.3 ohm - LIF TOY 3.9 ohm - 1 hr/day

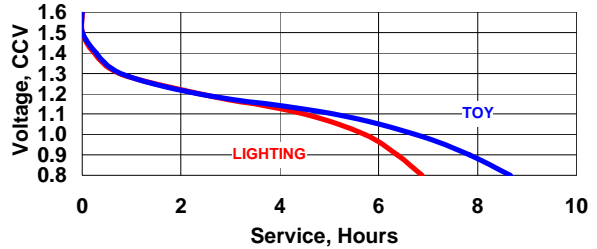

REMOTE  
24 ohm - 15 spm - 8 hr/day



TAPE PLAYER  
100 mA - 1 hr/day

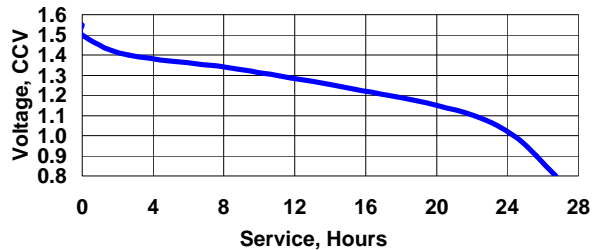

CD / MD / ELEC GAME  
250 mA - 1 hr/day

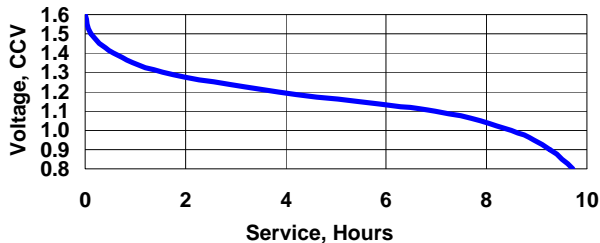

DIGITAL CAMERA 1.5/6.5K mW 2/28s 10X/hr PHOTO 1000 mA 10 sec/min 1 hr/day

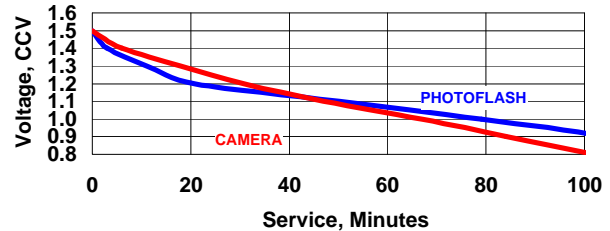

### Important Notice

This data sheet contains information specific to batteries manufactured at the time of its publication.

**Contents herein do not constitute a warranty.**

Copyright © Eveready Battery Co. - All rights reserved